

Installation instruction SF letters – Single letters with single converters

1., Purchased parts package

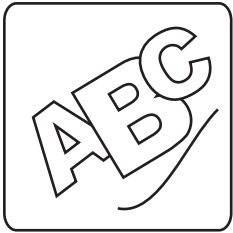

letters with cable connection

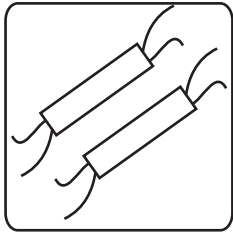

converters

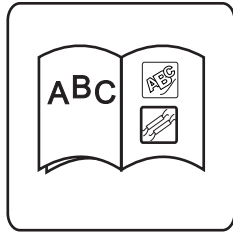

wiring diagram and assembling aid

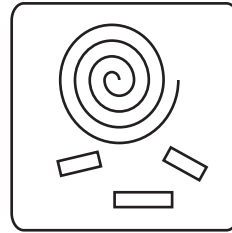

incidentals

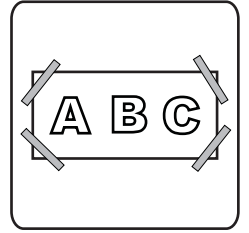

installation drawing

2., Fastening of the letters

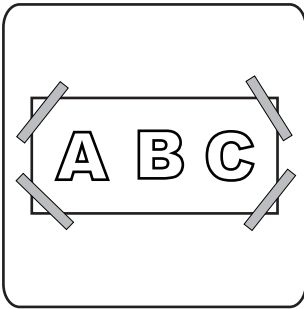

1., Adjust the drawing

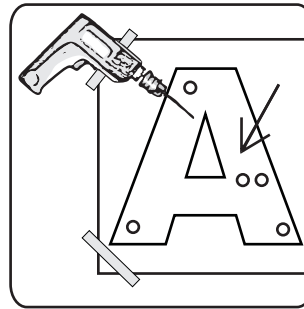

2., Drill the fixing and cable holes according to the drawing

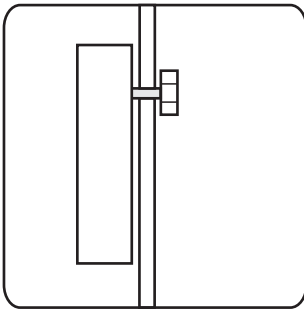

3., Fix the letters

3., Wiring of letters to converters

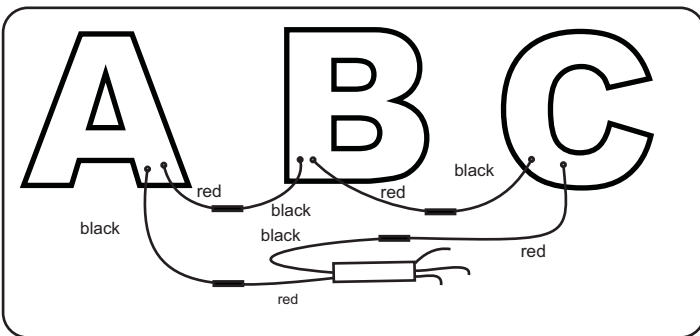

S-E-R-I-E-S C-O-N-N-E-C-T-I-O-N!

Always connect a red wire to a black one as shown in the picture.

Attention!

Inversion of the wires can cause damages and malfunction!

4., Proper connection of wires

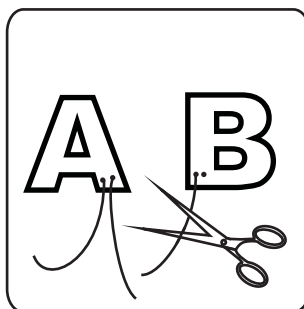

1., Cut wires to length

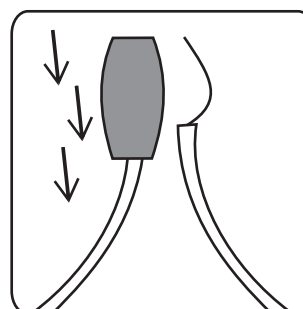

2., Impose shrink hose on

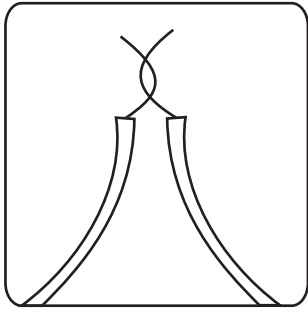

3., Strip 2-3cm of insulation and twist wires

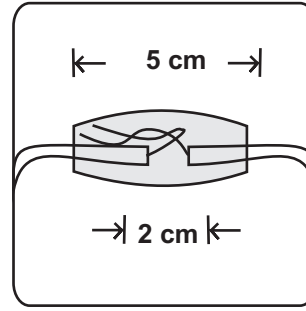

4., Turn wires down and position middle of the hose over the twisted wires

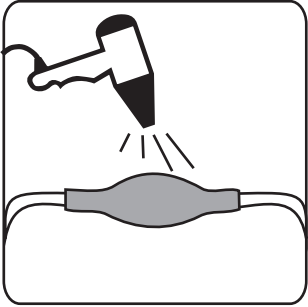

5., Heat hose with hot air or fire until the joint has been completely closed

5., Installation of converters and power connection

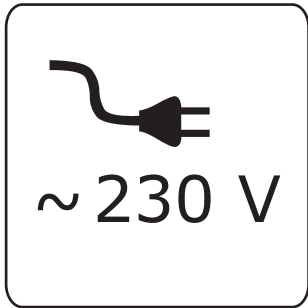

Accurate power supply voltage: 230V

Connection should be made by a certified electrician.

Attention!

Keep distance between converters.
Care for proper ventilation.
Keep out of strong solar radiation and permanent humidity.
Power connection according to standard:
brown – phase, blue – null, yellow-green - earth

6., Necessarily avoid!

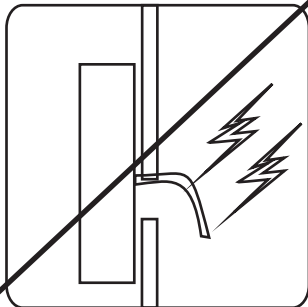

Attention!

Avoid connecting earth to LED wire!

Damages on wire insulation and short circuit cause destruction of LEDs and converters.

If all connections were made properly and our instructions followed, your signage will work reliably.